

BONALDO

Olos bed

Designer: **Mauro Lipparini**



Кровать семейства Olos, разработанная Мауро Липпарини и вдохновленная скандинавским дизайном, представляет собой набирающую популярность изящную стилистическую интерпретацию пространства для сна. Благодаря особой эстетической чувствительности и гармонии объемов, коллекция Olos позволяет в полной мере насладиться той интимной обстановкой, которая необходима для спальни. Основными характеристиками кровати являются современная элегантность, чистота форм и яркая индивидуальность. Сдержанные детали

изогнутого дерева позволяют немного увеличивать границы периметра, придавая изголовью слегка эллиптическую обволакивающую форму, добавляющую уюта. Вы также можете выбрать вариант с более высокой рамой кровати (Olos bed plus), вариант с высоким изголовьем (Olos bed hi) или вариант с ящиком для хранения (Olos bed open). Все эти варианты можно комбинировать, чтобы удовлетворить самые разные запросы и пожелания.



Технические данные

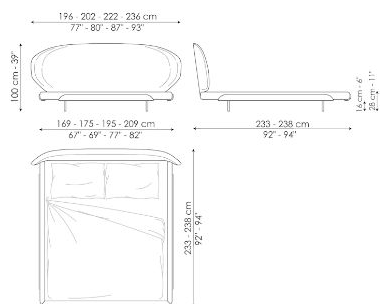

Olos bed

Ширина: 196-202-220-236см

Глубина: 233-238см

Высота: 100см

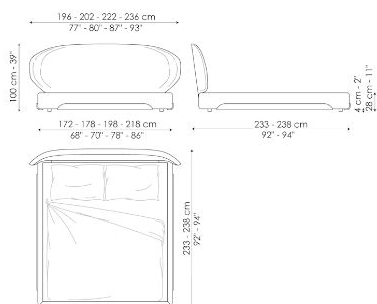

Olos bed plus

Ширина: 196-202-220-236см

Глубина: 233-238см

Высота: 100см

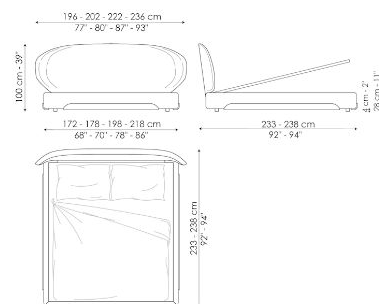

Olos bed open

Ширина: 196-202-220-236см

Глубина: 233-238см

Высота: 100см

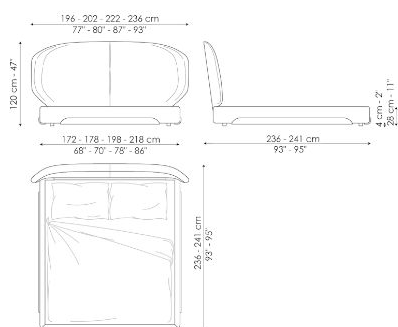

Olos bed hi plus

Ширина: 196-202-220-236см

Глубина: 236-241см

Высота: 120см

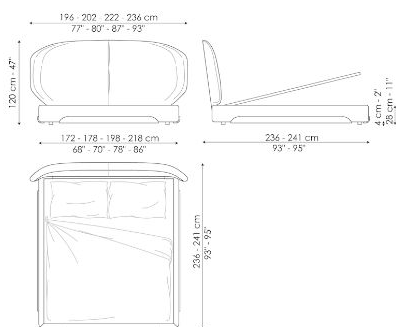

Olos bed hi open

Ширина: 196-202-220-236см

Глубина: 236-241см

Высота: 120см

Finishes

ОБИВКА

Ткань - 900

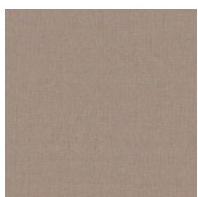

Ткань - Azimut
9B02



Ткань - Azimut
9B08

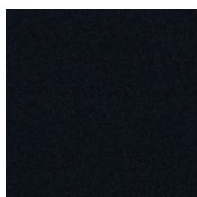

Ткань - Azimut
9B17



Ткань - Azimut
9B22



Ткань - Azimut
9B26



Ткань - Azimut
9B36



Ткань - Azimut
9B39



Ткань - Azimut
9B42

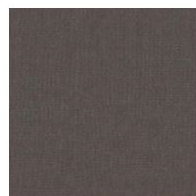

Ткань - Azimut
9B44



Ткань - Azimut
9B48



Fabric - Newco
9B65

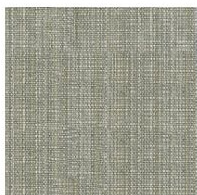

Fabric - Newco
9B66



Fabric - Newco
9B67



Fabric - Newco
9B68



Fabric - Newco
9B69



Fabric - Newco
9B70



Fabric - Newco
9B71



Fabric - Newco
9B72

Ткань - Must



Ткань - Boemian
MC40

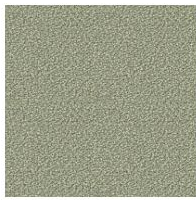

Ткань - Boemian
MC43

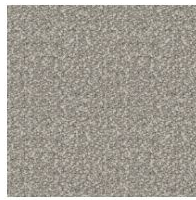

Ткань - Boemian
MC46



Ткань - Boemian
MC47



Ткань - Boemian
MC49



Ткань - Rico
MA02

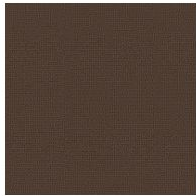

Ткань - Rico
MA04

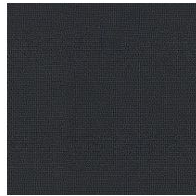

Ткань - Rico
MA07



Ткань - Rico
MA09



Ткань - Rico
MA11



Ткань - Rico
MA20

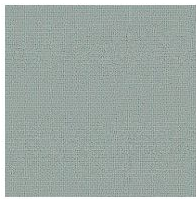

Ткань - Rico
MA22

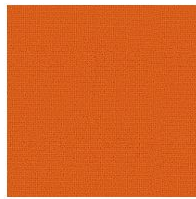

Ткань - Rico
MA39



Ткань - St. Moritz
MC60



Ткань - St. Moritz
MC61



Ткань - St. Moritz
MC62



Ткань - St. Moritz
MC67



Ткань - St. Moritz
MC69

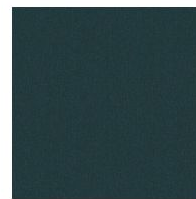

Ткань - St. Moritz
MC76



Ткань - St. Moritz
MC81

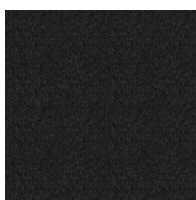

Ткань - St. Moritz
MC83

Ткань - St. Moritz
MC85



Ткань - Flora
MD30



Ткань - Flora
MD31



Ткань - Flora
MD32



Ткань - Flora
MD34



Ткань - Flora
MD35



Ткань - Flora
MD37



Ткань - Flora
MD39



Ткань - Nacchero
MD41

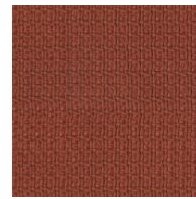

Ткань - Nacchero
MD44



Ткань - Nacchero
MD45



Ткань - Nacchero
MD47



Ткань - Nacchero
MD48

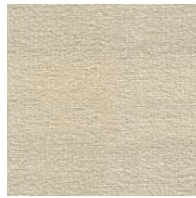

Fabric - Lucky
MD58



Fabric - Lucky
MD59



Fabric - Lucky
MD60



Fabric - Lucky
MD61

Ткань - Special



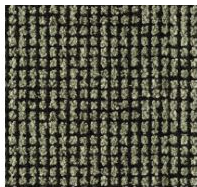

Ткань - Brionne
SP19



Ткань - Brionne
SP20



Ткань - Brionne
SP21



Ткань - Brionne
SP22



Ткань - Brionne
SP23

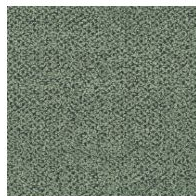

Ткань - Rella
SP01

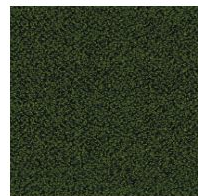

Ткань - Rella
SP04



Ткань - Rella
SP05

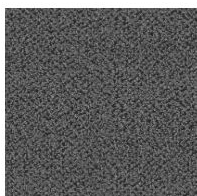

Ткань - Rella
SP06



Ткань - Rella
SP07



Ткань
SP39

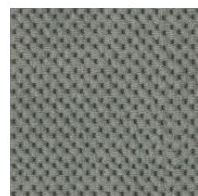

Ткань
SP40

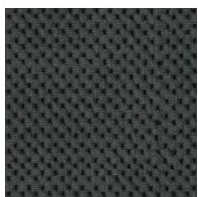

Ткань
SP41

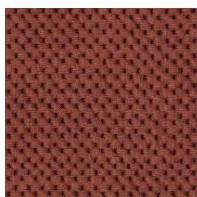

Ткань
SP42

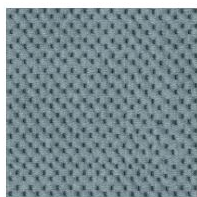

Ткань
SP43



Ткань
SP44



Ткань - Diamon
Frisé
SP31



Ткань - Diamon
Frisé
SP33

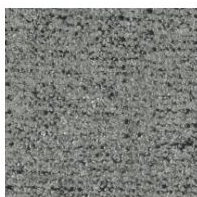

Ткань - Diamon
Frisé
SP36



Ткань - Diamon
Frisé
SP34



Ткань - Diamon
Frisé
SP38



Ткань - Baia
SP45



Ткань - Baia
SP48



Ткань - Baia
SP50

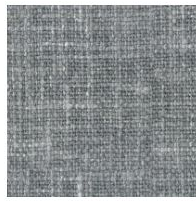

Ткань - Baia
SP51



Ткань - Baia
SP52



Fabric - Jurga
SP53



Fabric - Jurga
SP54

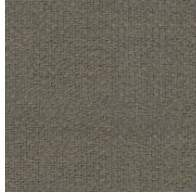

Fabric - Jurga
SP55



Fabric - Jurga
SP56

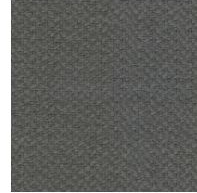

Fabric - Jurga
SP57



Fabric - Jurga
SP58

Ткань - 800



Ткань - Pastello
8D69



Fabric - Pastello
8D68



Fabric - Pastello
8D67



Fabric - Pastello
8D66

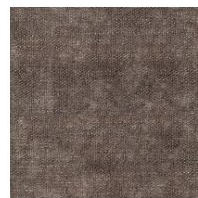

Fabric - Pastello
8D65



Fabric - Pastello
8D64



Fabric - Pastello
8D63



Fabric - Pastello
8D62



Fabric - Pastello
8D61

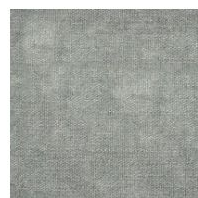

Fabric - Pastello
8D60



Fabric - Pastello
8D59



Fabric - Pastello
8D58



Fabric - Pastello
8D57



Fabric - Pastello
8D56



Fabric - Pastello
8D55



Fabric - Pastello
8D54



Fabric - Pastello
8D53



Fabric - Pastello
8D52

Ткань - Class



Fabric - Hyle
EB55



Fabric - Hyle
EB56



Fabric - Hyle
EB57



Fabric - Hyle
EB58



Fabric - Hyle
EB59



Fabric - Hyle
EB60



Fabric - Hyle
EB61



Fabric - Hyle
EB62



Fabric - Hyle
EB63

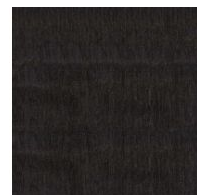

Fabric - Hyle
EB64

СТРУКТУРА

дерево



Шпонированное
дерево
Черный орех

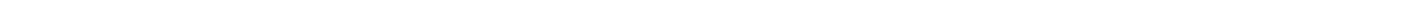

НОЖКИ

Металл категория Plus



Крашенный металл
Матовый
бронзовый

Materials, fabrics, leathers, colors and finishes are approximate and may slightly differ from actual ones. You can find the complete collection of Bonaldo fabrics and leathers on the website

